

| | |
|---|---|
|  <p>INTERACTION DESIGN INSTITUTE IVREA</p> | <p>Fine Skins 'Touch me' at the Victoria & Albert Museum</p> |
|---|---|

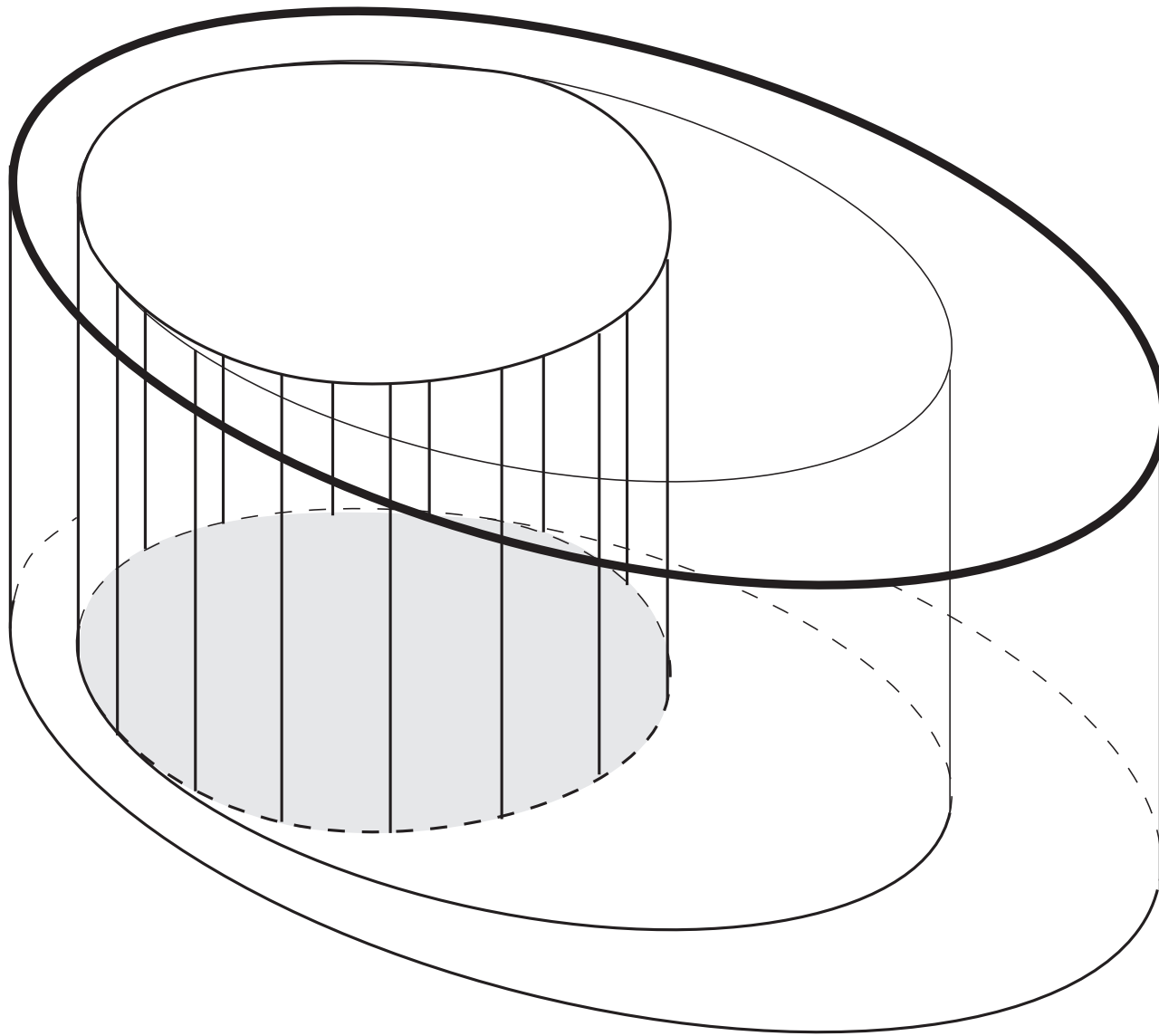

Fine Skins

Project Presentation

Structure of Presentation

This document is a presentation of the project Fine Skins, a sensorial lounge developed for the exhibition 'Touch Me' at the Victoria & Albert museum located in London.

The document is sectioned into four parts showing various examples of existing projects used as references, a description of the general concept. Which senses is being addressed and in which way one may interact in order to experience them. The architecture of the space targeted at a particular space within the V&A and the overall timeline and budget for the project.

1. References
2. Concept
3. Senses
4. Space

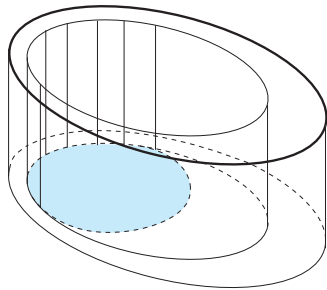

1. REFERENCES

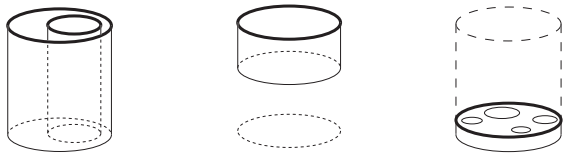

2. CONCEPT

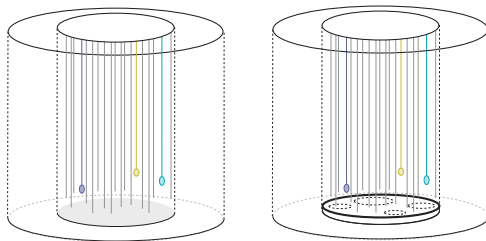

3. SENSES

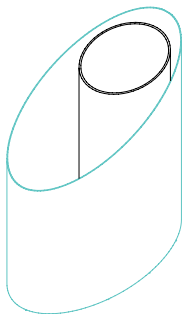

4. SPACE



1. References

Re-Lounge

An immersive re-generation zone for global air travelers. Designer Line Ulrika Christiansen created an experiential space that provides re-generation through relaxing and playful sensorial experiences of destination-related images, sounds and colours that travellers can activate through movements and a reactive pillow.

Re-Lounge is designed for a single user experience that with the use of an identification card is able to remember each users preferences to enable a personalized experience.

A touchDown zone, is located outside the space and will recognise personalised settings by each visitor and guide the traveler to the space . The reactive pillow, a dreamPillow is placed inside the Re-Lounge and receives the personalised data. The dreamPillow functions as an interface for the surrounding space by squeezing, stretching, stroking or simply by movement of the body to activate different outputs of light and moving imagery.

It serves as well as an alarm clock through vibration, which activates according to the travelers boarding time.

Inside Re-Lounge a modifiable sound system is installed, which is based on the human intuition and motion as there is no need for touch in order to play with the sound.

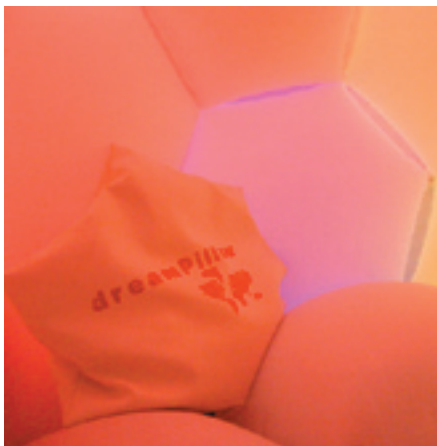

CICCIO

Curiously-Inflated-Computer-Controlled
-Interactive-Object by the Ciccio Group at Inter-
action Design Institute Ivrea.

Some sewn pieces of nylon in the shape of either a torpedo, or a sphere or a donut, then a small blower, a computer, few sensors, a projector, an optimistic look at the future, the desire to experiment and then here we have CICCIO!

CICCIO is light, inflatable, transportable, white, neutral, bright, coloured, projected; it has been hung and laid down and it has been used either as vertical or horizontal space; made in the shape of a donut, a torpedo and sphere; built in Ivrea but then inflated it in Rome, Florence, Milan, Turin, Genoa, London, Bangkok, Beijing, Copenhagen, Venice, Lille and the next one will be...

CICCIO is totally an opensource platform that everyone can use, copy, modify, distribute in order to learn how to teach; to learn how to learn both space and interactivity; to learn how to make a fast prototype of spatial interfaces; to learn how to experiment simple technologies that in the next future will be implanted in our quotidian living environment: houses, shops, square, cities.



This is Today

The Invasion of the Interactive Bodysnatchers.

This project was made by Interaction-Ivrea in collaboration with Cliotraat.

The body snatchers arrive at the Triennale and take possession at the Triennale in Milan. The interior is dark and lit with dots from coloured neon cylinders. Giving the space an atmosphere of mystery.



Visitors have to walk upwards through the space, and you venture up the steps, gradually discovering the various projects on show. In the air, a constant sound accompaniment takes you through the displays, highlighting the main points of your discoveries with the sounds (suitably distorted and transformed) of your daily life. Since it's invisible, the setting makes a big impression.

The interaction designer is the “friendly alien”, who can rework the past - viewed in a covertly retro way - and use it to look at the future through “human” lenses. This is the “creative body snatcher”, who exploits technologies to create objects and services that offer us moments of light-hearted fun as well as pure aesthetic enjoyment.

Illy Relax Area

In the buildings of the Corderie of the Arsenale at the Venice Biennale Studio Cliostroaat created relax areas for Illy.

They represented Illy by using its trademark icon, the red square. The red square is transformed into a three dimensional volume.

Out of this volume they carved out an inner square and got an external frame using the void. The void is still used as a second piece but in its positive form.

The frame was placed vertical and the inner square horizontal. One could sit in the frame and use the horizontal element as a table

These are spaces in which the viewer can decide whether to relax, reflect on the impressions the exhibition has made, socialize or simply rest a while between one work of art and the next.

Here, visitors can appreciate services intended to foster enlightened yet relaxing enjoyment of the exhibition. They will find comfortable seating, opportunities to meet and to learn, ways of delving deeper into the artistic content - information on the Biennale itself, the artists, the exhibits, the curators and the countries represented - and here freshly-made espresso coffee will be available.



The Fourth Sex

In the Leopolda exhibit area in Florence, Studio Cliostrat designed the setting for the exhibit Quarto Sesso.

What was interesting and relating to the system thought for Light Skins is again the use of a positive/negative use of form.

The elements was square forms using the void as the space for physical elements whereas the outside surface was used for large visuals.



One of the square elements was suspended from the ceiling. The form was closed with only a hole in which one could enter only with the top half of the body. It created a closed space for the visual experience though still being located in the larger exhibition space.

Toyo Ito

The exhibition created by the Japanese architect, Toyo Ito, shows several columns suspended between the ceiling and flooring.

The columns are filled with light coming from projections of various imagery to a smaller platform surrounded in semi-transparent fabric creating the columns.

The light columns amplify the space with a dark and mysterious atmosphere. The contrast of the light and dark defines a maze path and the projections on the horizontal and vertical surfaces give birth to white and multicolored light effects.

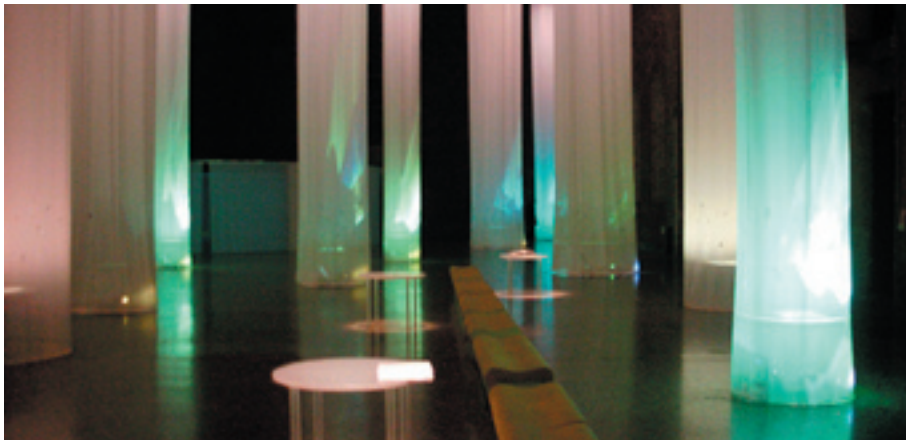

Soft Interface

A switch as soft as a ball of gel...

Designer Akemi Tazaki, worked with the concept of soft interfaces and questioned whether it is possible to design and prototype a soft, fluid switch - a switch that makes us really want to touch it, and that transform a banal everyday gesture into a new sensory experience?

The answer is angelic, a first step towards a world in which the softness of gel is taken from the beauty-preparations counter and put onto our bathroom walls.

Using the concept of a soft interface it opens up for a world of materials that make us able to integrate interfaces in soft volumes and rounded shapes. It creates a much enhanced sensorial of interacting with a control rather than the typically used controls.

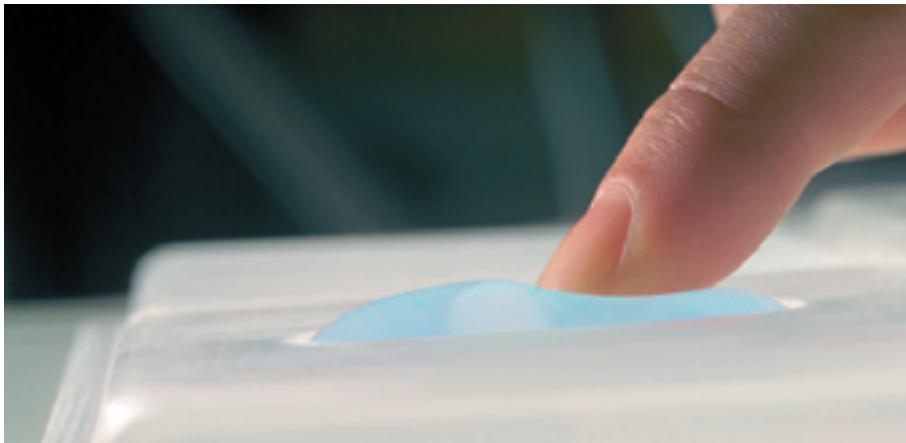

Bangkok

For an exhibition in Bangkok the architects, Rachaporn Choochuey and Stefano Mirti, created open/closed spaces by dividing smaller circular space units from the overall space with the use of strings suspended from ceiling to floor.

A set of long small chains attached at a hanging metal structure creates the cylindrical spaces and give shapes to solid vs. empty volumes along the visitors paths.

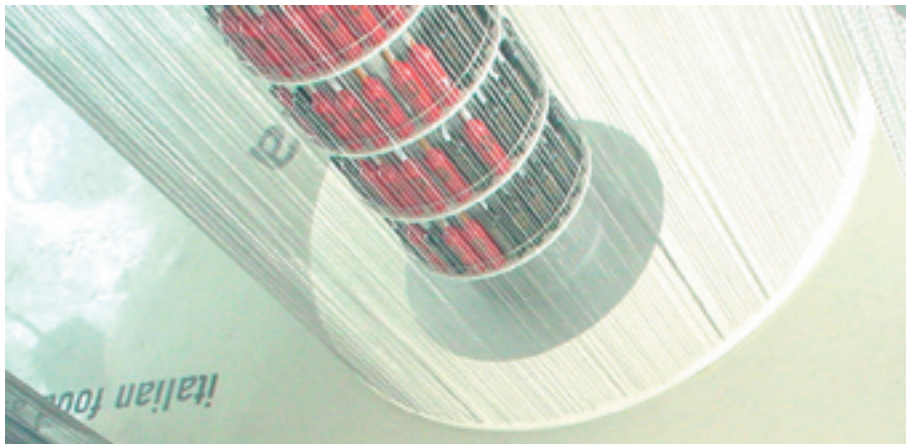

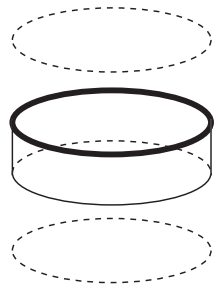
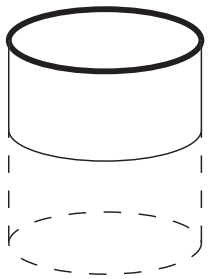
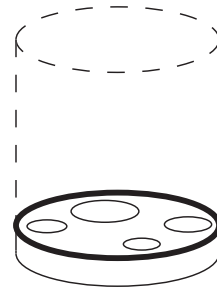
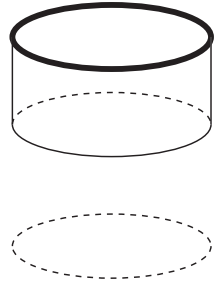
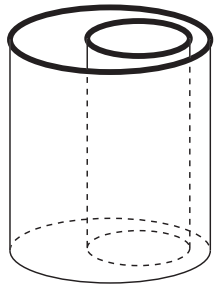

2. Concept

Touch

The sense of touch is the first sense we develop as a human being, and the only sense that covers our whole bodies though touch is often neglected when interfaces to digital objects are created. Most interfaces to digital devices are based on sound and vision and only rarely employ the sense of touch.

Instinctively we reach out to touch those objects that attract or perplex. Touch conveys an intimacy both at a physical and emotional level.

We will combine the thought; 'seeing is believing but it is touch that determines reality' by using touch as the only input to interaction with a space but with the output playing with all the senses.

The interactive objects or surfaces will use different materials that each will allow for a different sensation.

The interaction will be integrated in the seating as well as the objects suspended in the space.



Experience

Our experiences of space oscillate through constructions, deconstructions and reconstructions and interactions with real and virtual spaces. Spaces comprised of a milieu of relationships between bodies, objects, surroundings, images, cultures, events, sounds etc.

These bodily movements through different postures, speeds, orientations and durations affect how we experience, think, connect and relate in our present surrounding.

In other words, it is in the interfaces and in the relationships between different interactions, spatial, temporal and visual alignments that construct our experiences.

The experience of Fine Skins will be building on the stimulation of the visual sense, sound, motion and touch, as well as the use of vibration to effect the spatial surrounding.

Fine Skins is a re-generation zone either for a single user experience or in a cluster of several units put together to create an experience for a larger number of people to be involved.

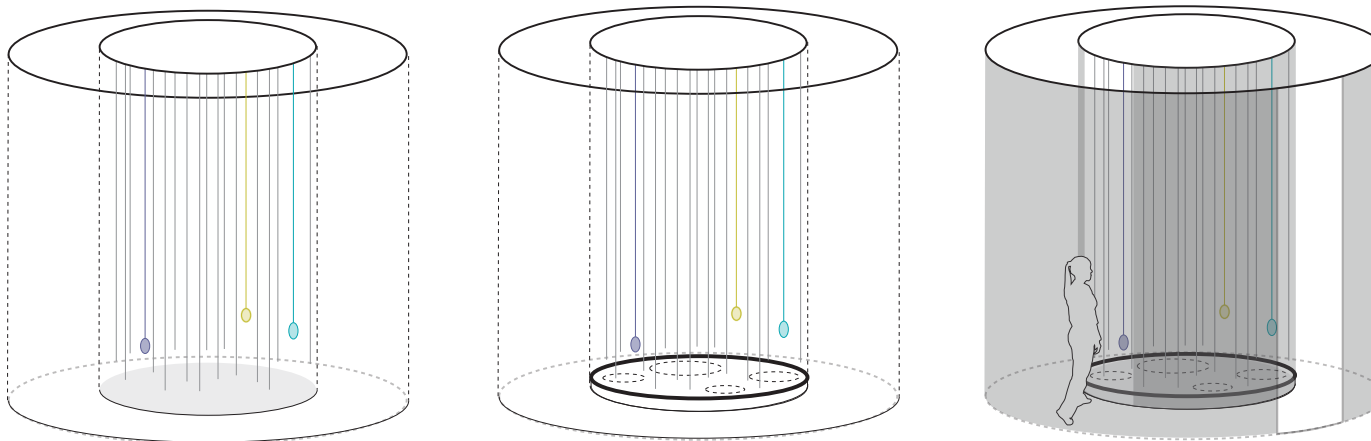

Conceptual Space

The space consists of a spheric system that can be only one module unit for a few persons or as a flexible system that can be transformed into a larger form can create several units within a larger space.

The spheric form can be expanded and matched together with several units creating a larger space able to contain several persons. In this space it allows to create interactions between several people and not just a single use or between two people.

For the Touch Me exhibit only a single unit will be installed created by two layers. The form is ellipse and constructed of semi-transparent light fabric suspended from the ceiling.

If viewed from above the form creates the view of an egg made of an outer shell and the second layer creates the inner membrane before entering the centre.

By the use of a flexible material such as fabric we create the experience of being merged between layers, ie. the skins.

We will use a layered system where the shadow play of the bodies in the space will be more and more diffused from the outside as they enter the layers.

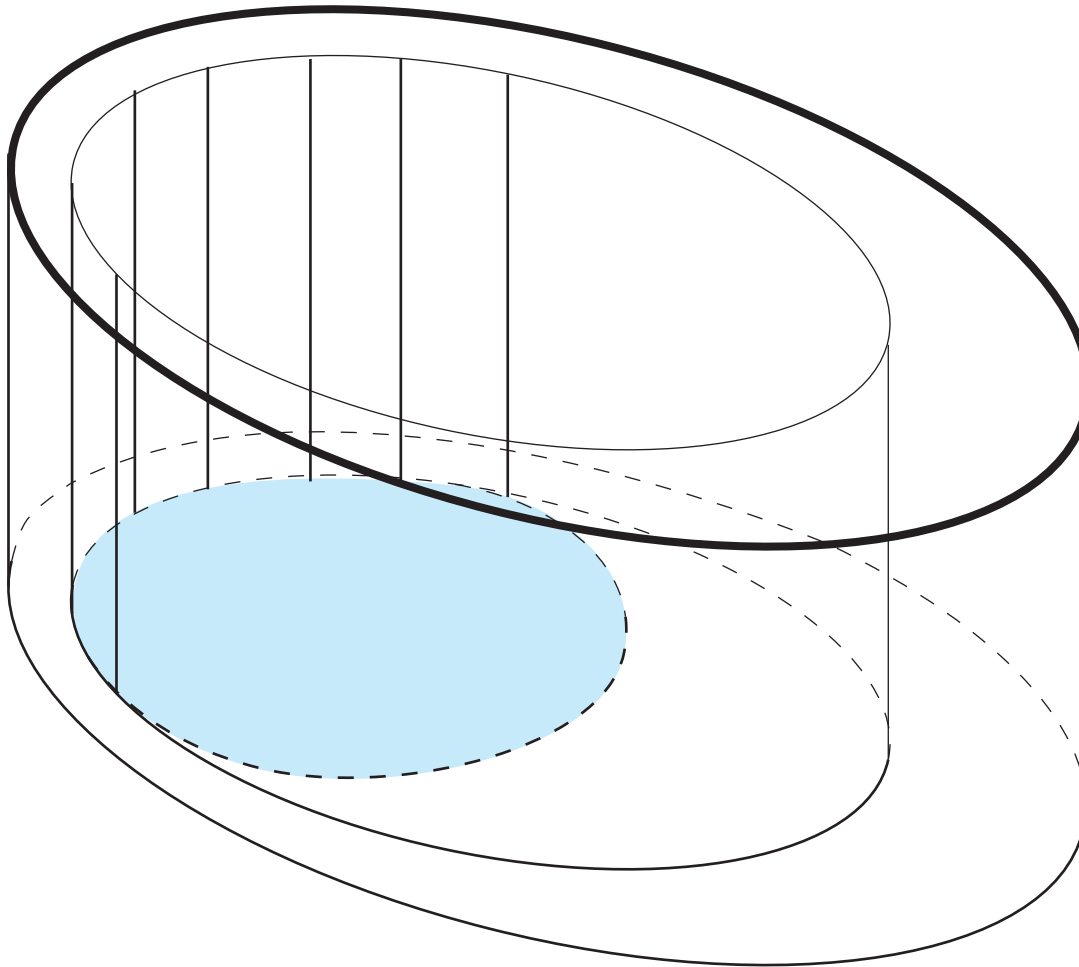

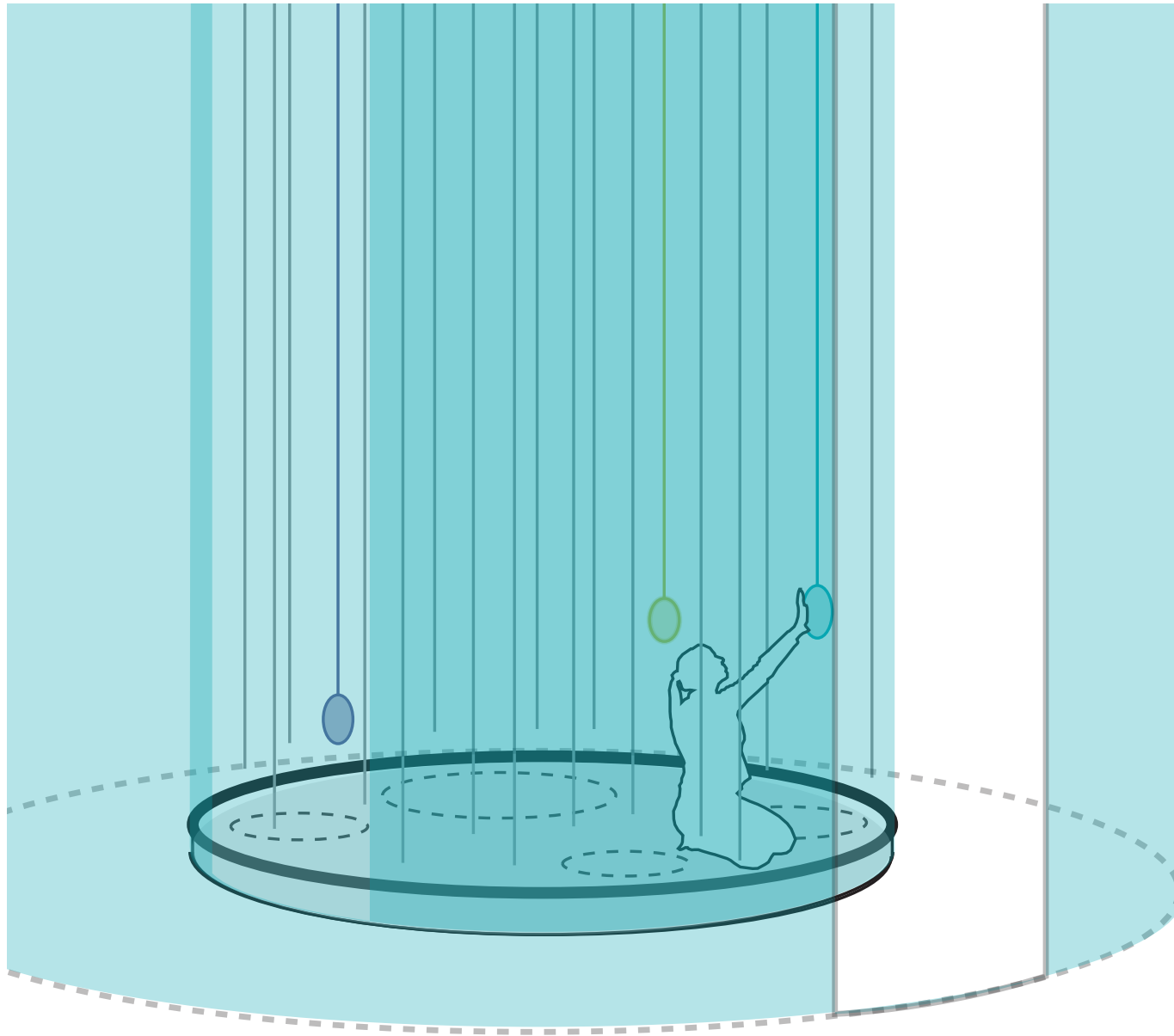

3. Senses

Vision

The Fine Skins draws on the emotional language of light and the emotional language of touch. The result cannot help being a continual surprise, which, - according to individual experience - goes beyond the mechanisms and physical theories at the basis of perception.

The use of light is born not only out of a desire to explore the fascinating relationship between shape and light and to initiate a reflection which would cross the border between art and science, but also, and most importantly, to become an invitation to conjure up magic, using light - with its mysterious and archetypal power to arouse strong sensorial and psychic reactions.

The light is created with neon light of different colourshade using each light with a color scale from dark to bright. When a visitor interacts with the sensors hanging form the ceiling a specific colour loop occurs changing the perception of the space.

The neon lights are hooked up to a transformer that then again is hooked up to a computer processing the data when the interaction occurs. The interaction is initiated by touching an object of material still tbd, suspended from the ceiling.

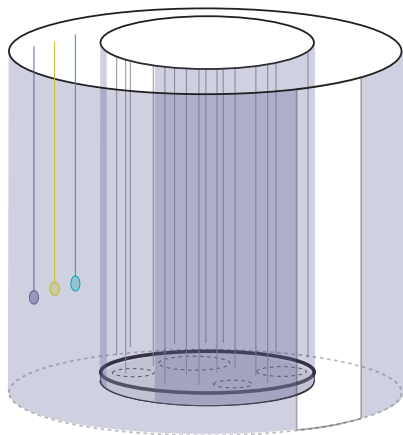

The colorshade of blue is in its dark shade and no one is interacting.

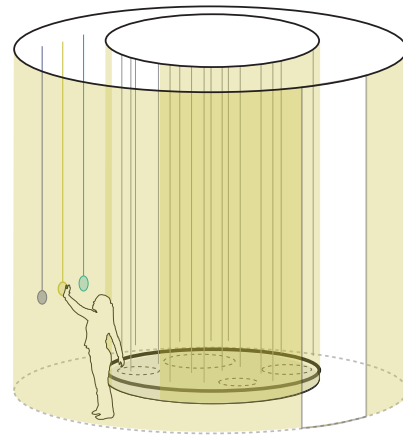

A visitor has triggered the blue scale and the space is transformed all yellow, looping from bright to dark.

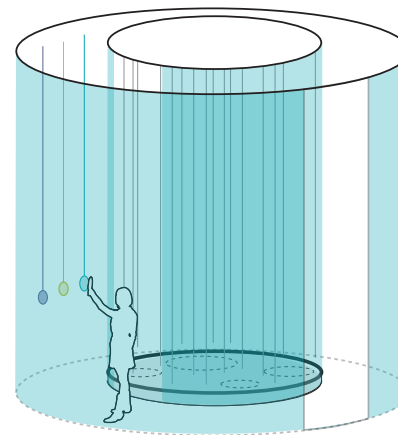

An interaction with the vision is occurring as a visitor touches the sensor.

Nerve

The sense of touch also includes awareness of vibrations triggered by the fine nerve system that covers our body surface. With vibration we address the sense of skin, the somatic sense.

The centre of the space will be circular. Not created by another layer of skin but simply by the form of the platform where seating is adjusted.

The platform will be of a foam material indicating the centre of the space on which a set of pillows is placed.

The seats will be used as interactive surfaces themselves. The pillows are stationary and once seated they will vibrate by the cause of pressure. Each area of vibration will have a different level of vibration.

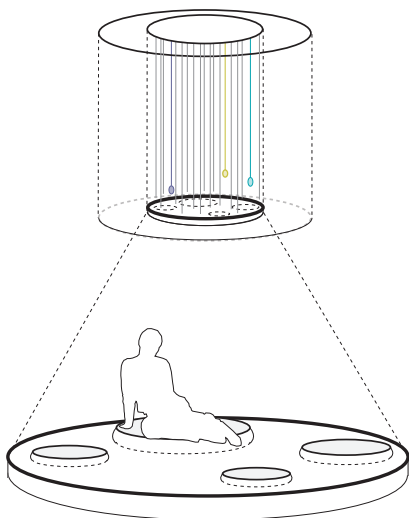

In the center of the space a circular seating platform is located. Height apx. 40 mm.

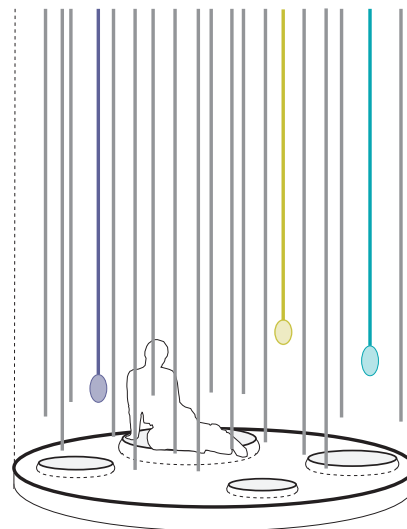

A visitor has come seated the platform on one of the indicated areas and triggered the interaction.

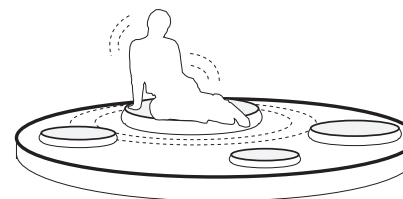

A vibration coming from the seating area occurs and the visitor can explore the different areas with their various sensitivity.

Sound

Hearing is one, the auditory, of the traditional five senses that we are addressing with the sensorial room. It refers to the ability to protect sound.

A space without sound is often perceived as a 'dead' space. By adding a layer of sound, one adds another dimension of space as well as addressing the sense of sound.

As explained earlier, the centre of the space will be created by a circular platform. Above, hanging from the ceiling, several rubber tubes will be hanging. The visitor will enter a dense forest of rubber tubes.

The material will be various indicating the ones interactive with a different material or density of the same compared to the rest.

By touching a rubber tube a sound loop will start. The sound will add to the sensation of perception of the space, not only for the one who triggered the loop, but as well for the other visitors viewing from the outside.

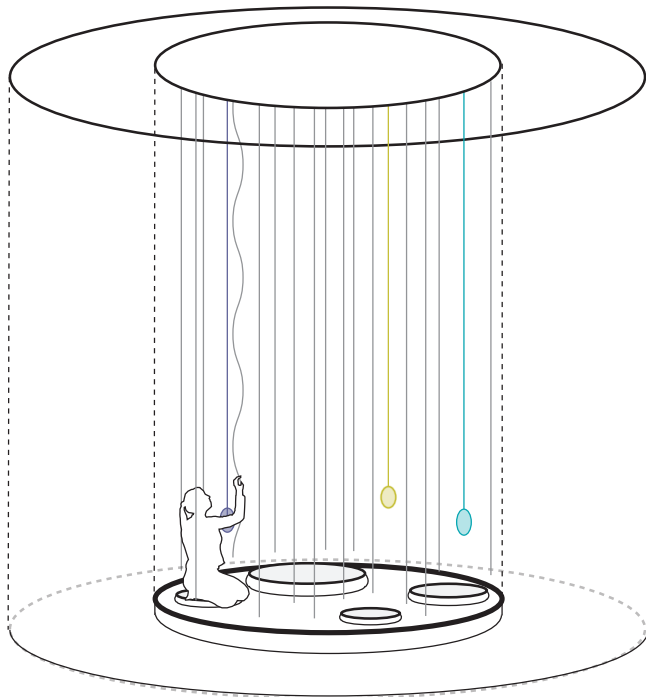

A visitor seated in the inner circle of the structure is entering a jungle of rubber tubes hangign from the ceiling.

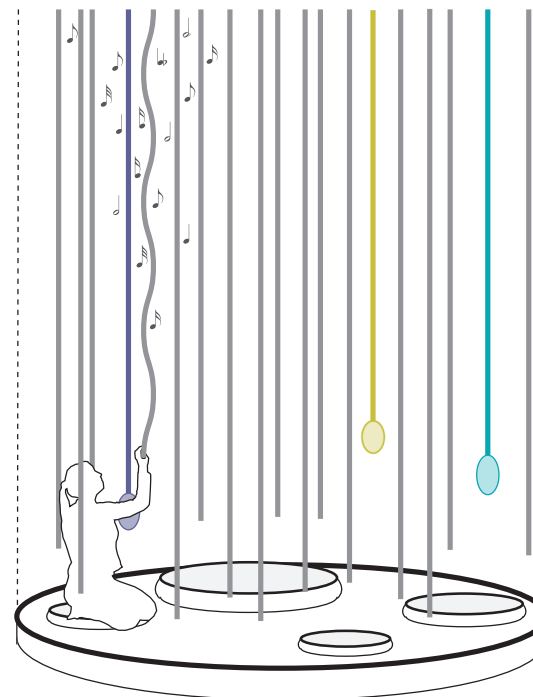

Some of the rubber tubes are interactive and by shaking them a sound loop will begin, transforming the perception of the space.

Taste & Scent

With the ability to sense over ten thousands different smells the sense becomes very important to our memory of places or situations. By applying a sense of smell to the experience we add a layer that will trigger the visitors memories and perhaps perception of the space.

The system we are imagining for such is not interactive in a technological sense but simply an effect that will add to the sensorial experience. This will complete the stimulation of the five senses.

Depending from the reply of possible sponsors we have addressed we will conclude whether these sense are possible to display. The method of display will be determined and adjusted to the possible sponsor.

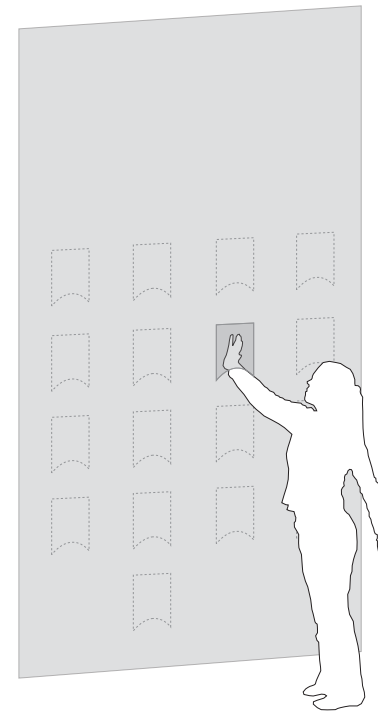
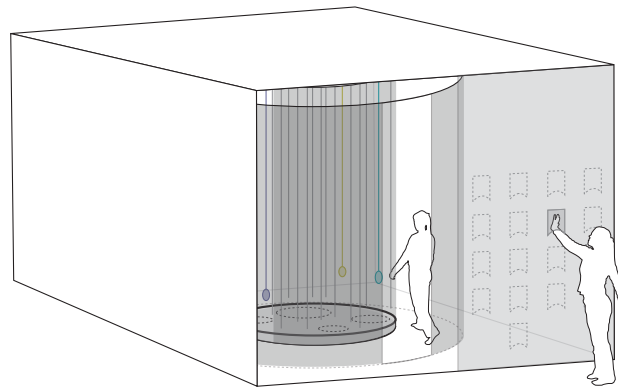
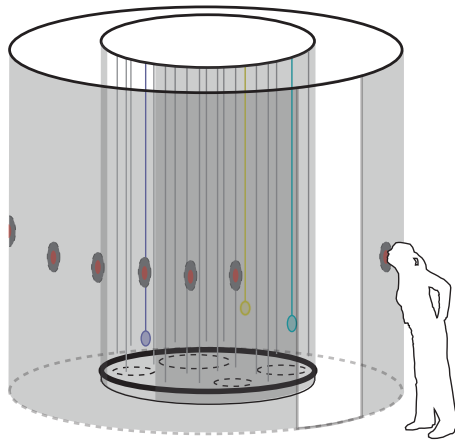

Small pockets with various scent is integrated in the skin and a visitor curiously smells the fragrance.

Little packages with different tastes in each is available for the visitor to take. These packages would all be white not to give any hints of the tastes.

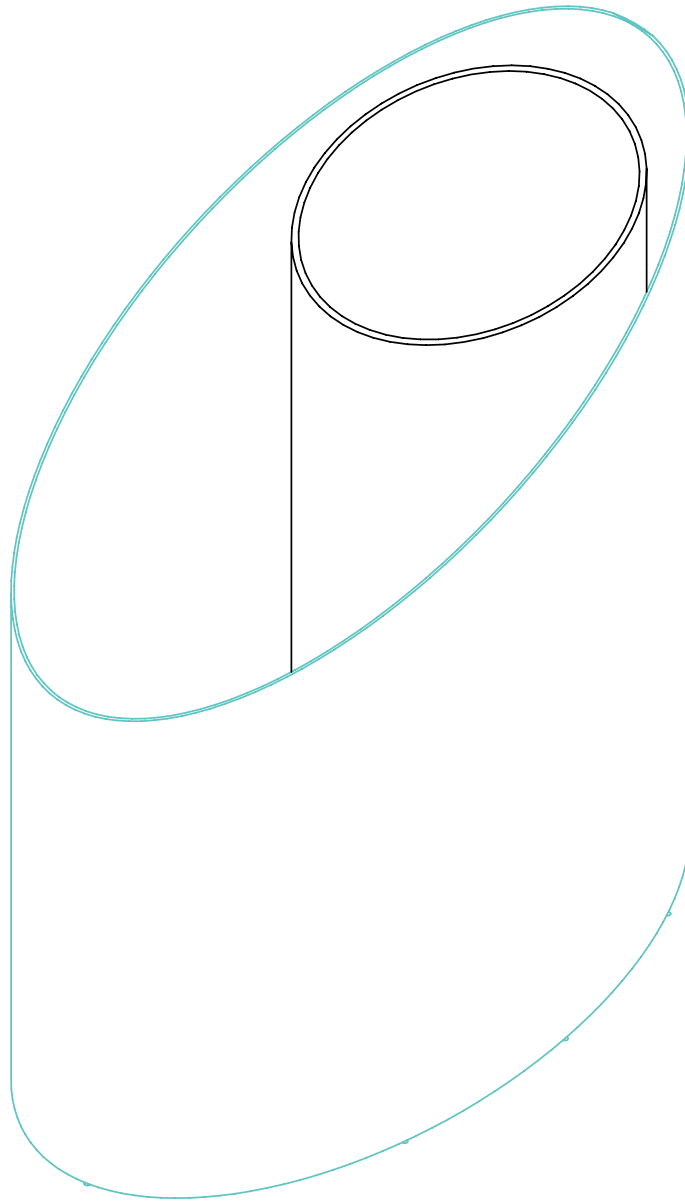

4. Space

Architecture

The accurate form for the space will be in a ellipse system of two layers, plus an inner open circular 'layer' indicated only by the use of the seating platform and the rubber tubes hanging from above controlling the sound.

The 3D models gives and idea of the system which we are imagining.

The system consists of a metal frame suspended from the ceiling carrying a textile that creates the space.

The space will have the feeling of hanging in air as will not reach the ground but leave a free space from the flooring to the edge of the textile. This will bring a lightness to the architecture.

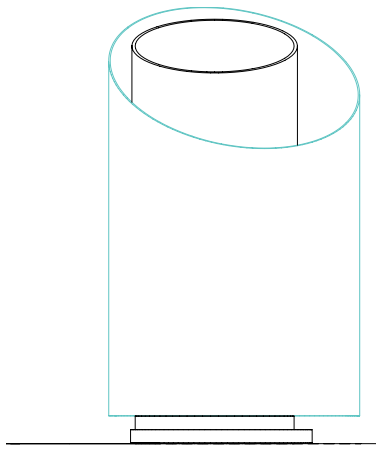

Frontal view.

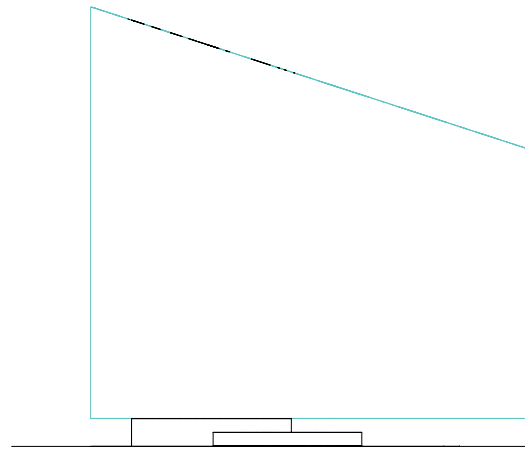

Cross sectional view.

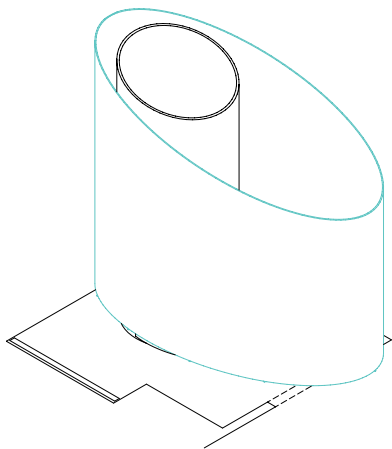

Side view A on plan.

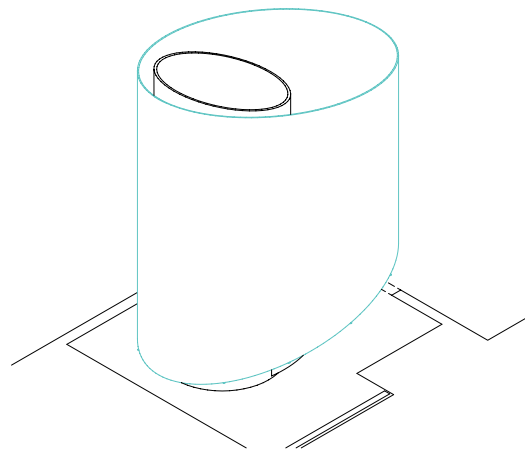

Rear view on plan.

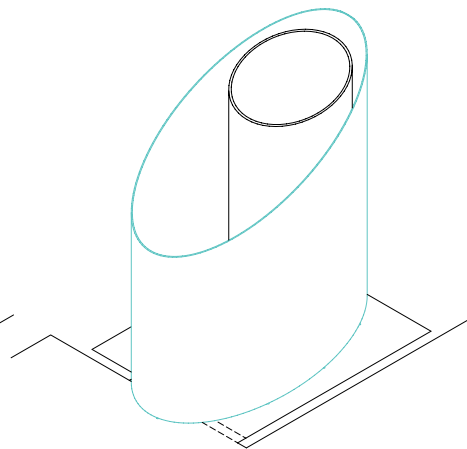

Side view B on plan.

Structure

Plan view.

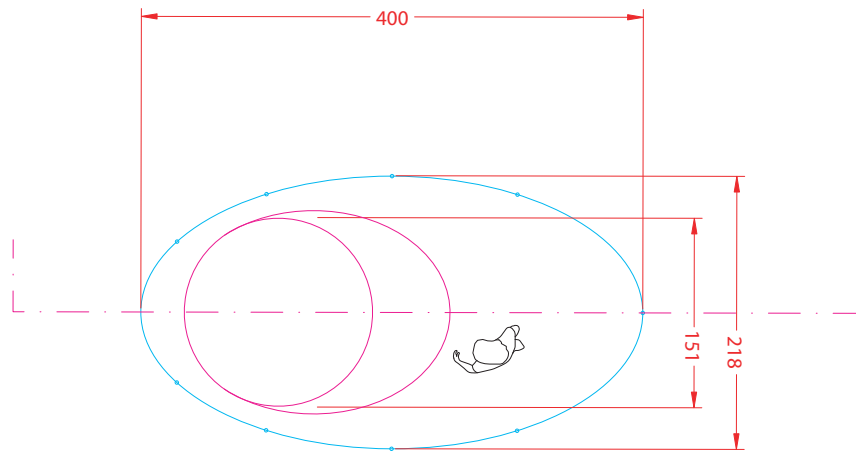

The metal structure suspended from the ceiling will be attached in an angle of apx. 72 degrees. This will allow the system to go through the door opening (only 300 mm high) and have a small facade that is to be seen from the larger gallery space.

By the illumination happening in the space, the view of the small facade will constantly change light and cause an interest when view view from afar.

Cross section.

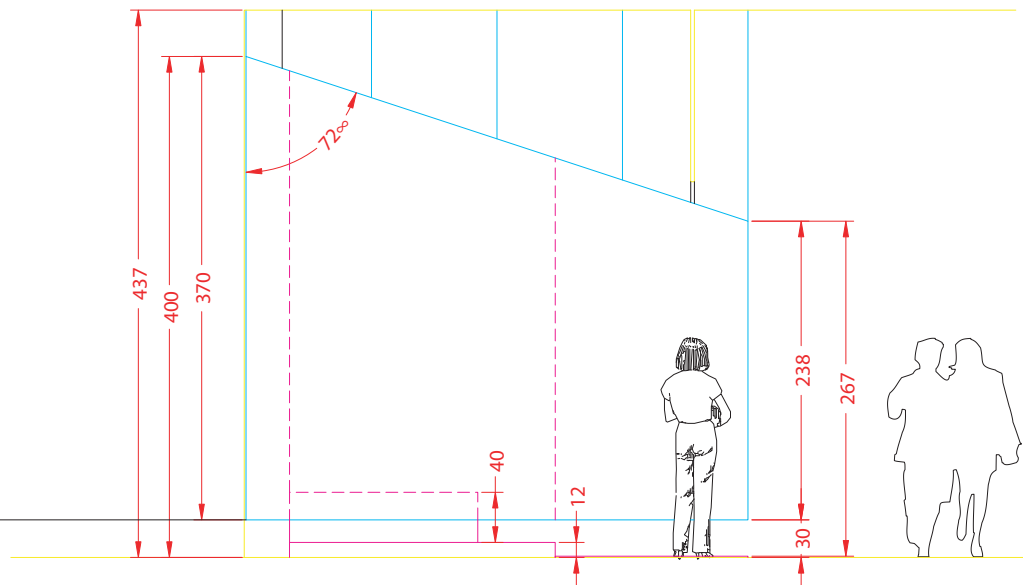

Gallery Plan

The Fine Skins sensorial space will be located in the former store room of the gallery space no. 62.

The structure is placed in the store room in such a way, that the space between the outer ellipse and the walls of the store room, can be used to place various electronic gear to make the interactive system running.

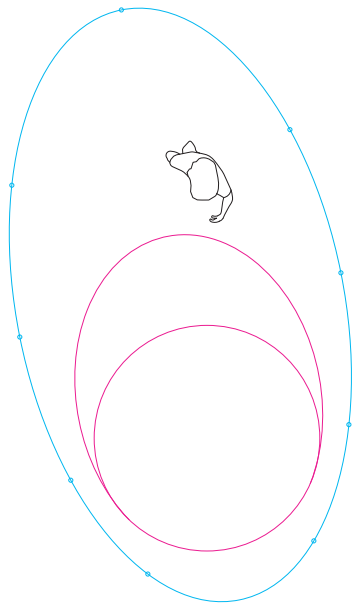

Cross section.

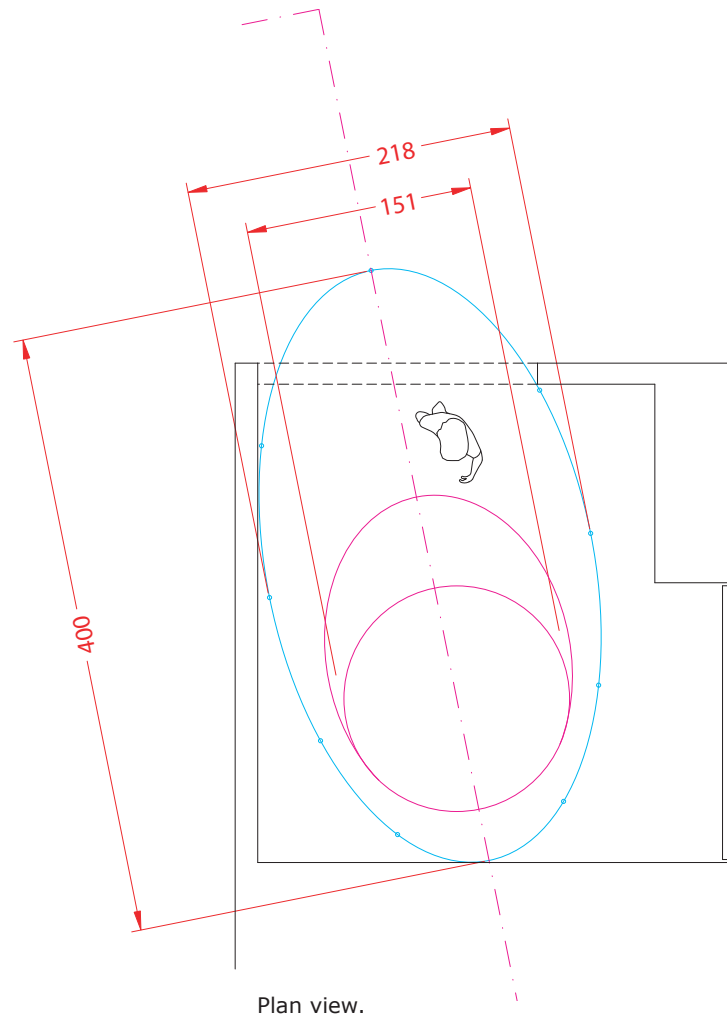

Plan view.

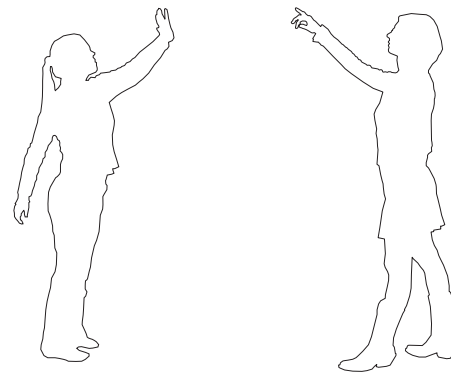

Credits

e1

Interaction Design Institute Ivrea
Line Ulrika Christiansen and Stefano Testa with
Daniele Mancini, Stefano Mirti, Matteo Pastore
and Francesca Sassaroli.

Unit2

Interaction Design Institute Ivrea
Massimo Bansi

StudioApe

Gianluca Alessio and Francesco Zannier

Textile consultant and support

Anna Barbara

Soundscapes

Rafaella Monzini

Scent/Taste consultant and support

Anna Barbara